

NEUATION



iFUGE M15K

PRODUCT USER MANUAL

CONTENTS

1. INTRODUCTION	1
2. INTENDED USE	1
3. SYMBOL	1
4. FEATURES	1
5. TECHNICAL SPECIFICATIONS	1
6. STANDARD ACCESSORIES	2
7. ROTOR AND REDUCED ADAPTORS	2
8. SAFETY PRECAUTIONS	3
9. INSTALLATION	4
10. ROTOR INSTALLATION	6
11. BALANCING THE ROTOR	6
12. OPERATION	7
13. TROUBLESHOOTING	9
14. MAINTENANCE AND CLEANING	11
15. WARRANTY STATEMENT	12
16. PRODUCT DISPOSAL	13

1. INTRODUCTION

This manual provides important safety information for this centrifuge. It should be kept near the centrifuge for quick & easy reference. This centrifuge is equipped with maintenance free brushless DC motor drive with microprocessor controlled and a safety feature of imbalance detection. The centrifuge is designed for high speed spin downs applications. Multiple rotor option makes it usable for wide range of applications.

2. INTENDED USE

This micro centrifuge is designed to separate, sediment, spin down aqueous solutions & solvent suspensions of differing densities in compatible sample containers.

NOTE: Before using the centrifuge, please read this user manual carefully. This user manual is intended to assist with the operation and care of the unit & is not a document which aids in repair. For repair please contact the supplier.

3. SYMBOL

 Warning	 Waste electrical
--	--

4. FEATURES

- Maximum volume of 12 x 2 ml
- Imbalance detector with auto cutoff for safe operation
- Brushless DC motor for maintenance free performance
- Lid lock safety-the lid opens automatically on run completion
- Digital display with speed and time indicator
- RPM setting from 500-15000 RPM with a count of 100
- One press changeover from RPM to RCF functionality
- Reduction adaptors for 0.1/0.2 & 0.5ml tubes
- Emergency lid release during power failure
- Automatic internal diagnosis & error display

5. TECHNICAL SPECIFICATION

Motor Type	Brushless DC Motor
Maximum Volume	12 x 2 ml (microtubes)
Speed Setting	500 to 15000 RPM
Maximum RCF	15596 x g
Speed Accuracy	± 100 RPM

5. TECHNICAL SPECIFICATION





Speed Steps	± 100 RPM
Noise Level	<60 dB (A)
Ambient Temperature	5-40°C
Permissible Relative Humidity	≤80%
Run Time	1 to 99 minutes & infinite mode
Acceleration time	≤ 65 Seconds
Deceleration time	≤ 55 Seconds
Size (L x W x H)	190 x 120 x 270 mm
Weight	2.450 Kg approx (with rotor)
Altitude	Use upto an altitude of 2000 m above MSL
Pollution Degree	2
Environment	For indoor use only
Power Adapter Details	Input: 100-240 VAC, 50/60 Hz Output: 24V $\overline{\text{---}}$ 4A
Power Consumption	72 W

6. STANDARD ACCESSORIES

- Power Adaptor
- 12 - slot rotor (Pre-installed) with reduction adaptors for 0.1/0.2 & 0.5ml tubes
- T-Allen Key
- Product user manual & warranty card
- PCR strip rotor (optional)

7. ROTOR AND REDUCED ADAPTORS

Below table shows the Maximum RCF of rotor and Maximum RCF with different tubes & adaptors.

12 tubes rotor	1.5/2.0ml tubes		0.5ml Adaptor		0.1/0.2ml Adaptor
					
	1.5/2 ml	0.5 ml	0.4 ml	0.2 ml	0.1 ml
Max. Speed	15000	15000	15000	15000	15000
Max. RCF	15596	12577	12074	11105	10278

7. ROTOR AND REDUCED ADAPTORS

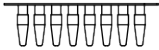
PCR strip rotor (Optional) 	0.1/0.2ml PCR strip 
Max. Speed	15000
Max. RCF	13080

NOTE: Always use recommended accessories for best result & product safety.

8. SAFETY PRECAUTIONS



Read all safety & usage information provided in this manual carefully before using the device.

- Never use the centrifuge in any manner not specified in this manual.
- Using equipment in any manner not specified in this manual or by the manufacturer, will void the warranty.
- Never move the centrifuge while the rotor is spinning.
- The rotor and the rotor lid must always be securely fastened. If the centrifuge makes unusual noise during operation, the rotor or rotor lid fit needs to be checked. Switch OFF the device immediately by pressing STOP, check rotor fit & fasten it well.
- The rotors must be loaded symmetrically. Each tube should be counter balanced by another tube of the same weight.
- Do not use the centrifuge or rotor that have not been correctly installed or damaged.
- Repairs must only be performed by authorized service technician.
- Using incorrect rotors & wrong spare parts will void the warranty.
- Centrifuge may be used for the specified applications only. It must not be operated in a hazardous or flammable environment and must not be used to centrifuge explosive or highly reactive substances.
- If liquids are spilled on the rotor or rotor chamber, the centrifuge must be cleaned carefully and properly before being used again.
- Prior to centrifugation, the tubes should be visually inspected for material damage. Damaged tubes may not be centrifuged. This is because broken tubes can, in addition to sample loss, create imbalance which can result in further damage to the centrifuge and accessories.
- The maximum capacity of tubes must not be exceed its corresponding rotor

8. SAFETY PRECAUTIONS

capacity. Do not use liquid with density higher than 1.2g/ml for full load operation.

- Do not lean on the equipment. It may damage the equipment or the harm the operator.
- When moving the centrifuge from a cold room to a normal room, run the centrifuge for 30 minutes beforehand in the cold room to avoid condensation. Alternately, allow it to warm up in the lab for at least 3 hours before use, but do not plug in the centrifuge in order to prevent possible damage by condensation.
- Be sure to close the tubes lid tightly prior to centrifugation. Open tubes lid can be torn off during centrifugation and can damage the rotor lid or centrifuge.
- Rotors and rotor lids are high-graded components which are subject to extreme mechanical strain. Even slight scratches and tears can lead to serious internal material damage. Ensure to check the rotor for any signs of damage before use. Rotor & rotor lid showing visible signs of corrosion or mechanical damage should not be used, contact your local supplier or mfg for replacement rotor & parts.
- Do not fill tubes while they are in the rotor. Liquid spillage may harm the device.
- In the event of contamination caused by aggressive agents, the rotor must be cleaned immediately using a natural cleaning liquid (like water). This is particularly important for the bores of the tubes. If any damage is seen, contact the service technician.
- Before using cleaning or decontamination methods, other than those stipulate by the manufacturer, contact the manufacturer to ensure that the intended method will not damage the centrifuge.
- “Tube Holders” are a part of the Rotor. They should be placed in the rotor whether 2, 3, 4, 6...12 tubes are being used.
- The power cord given with centrifuge unit is designed to use for that particular centrifuge. Do not use any other power cord, using any other power cord /adaptor may damage the centrifuge and will void the warranty.
- For safety we have provided protective earthing with power supply. Make sure power supply is earthened.

9. INSTALLATION

Gently remove the upper packaging and take out the centrifuge by holding it from the bottom. When the centrifuge is used for the first time, ensure that all the packaging and accessories are removed from the rotor chamber. The rotor is pre-installed. Please make sure that rotor is firmly tightened. Accessories and user manual are kept inside the box with the centrifuge. Please keep all the packaging in safe storage for at least 2 years for warranty purpose.

The following points are important for proper installation:

9. INSTALLATION

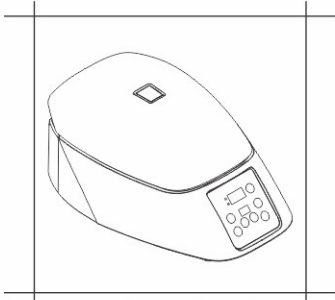

Must be used on Flat
& Non - Slippery Surface

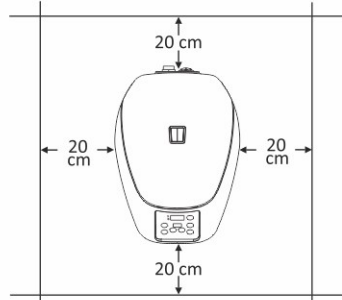

Must have Clearance of
20 cm from all 4 sides

9.1 CONNECTING POWER ADAPTOR

1. Connect one side of power adaptor to rear side of centrifuge and other to supply as shown in the figure below.
2. Rotate clockwise the adaptor nut to tighten the adaptor with the centrifuge. Ensure the power switch is OFF while connecting the power adaptor.

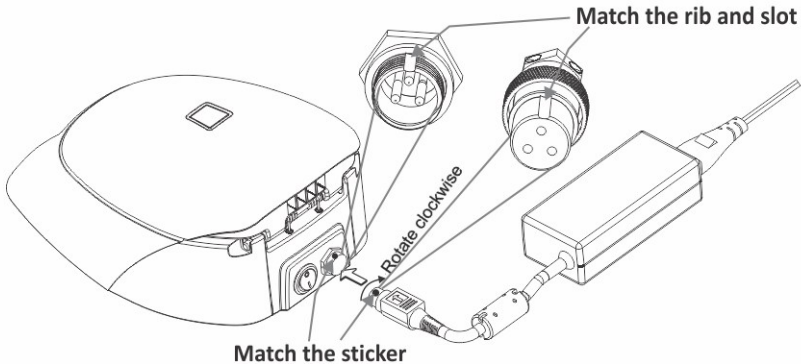

3. The sticker on the body & jack are indicating the position of the rib on the jack. While fitting the adaptor to the unit-please match the sticker position as shown in the figure below & gently push it in.
4. If matched correctly the plug will go in easily without much force (do not try to force the plug in if it is not matched properly). Once the plug is inserted into position, turn the loose upper ring clockwise to tighten & to secure the fitment.

10. ROTOR INSTALLATION

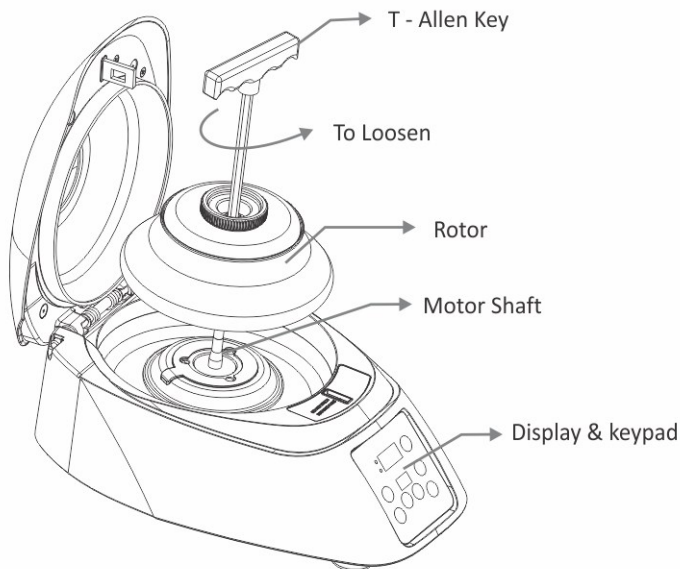

The rotor of the centrifuge is pre-installed. In case of any spillage, remove the rotor as shown in the above figure to clean the rotor and its chamber thoroughly.

10.1 REMOVING ROTOR

1. Using T-Allen key, loosen the rotor nut by rotating rotor nut counter clockwise and take the out rotor vertically.

10.2 INSTALLING THE ROTOR

1. Make sure the rotor shaft and the rotor mounting hole are clean. Load the rotor vertically into the motor shaft.
2. Put the T-Allen key in the rotor nut & turn clockwise to tighten the rotor.

11. BALANCING THE ROTOR

Always balance the rotor before centrifugation Symmetrical loading of tubes in the rotor is necessary. Otherwise vibration or imbalance can occur which can cause serious damage to the centrifuge. The following are process of symmetrical loading of centrifuge tubes inside the rotor. The samples in the tubes should be of equal volume. To achieve a balanced condition, "Reduction Adaptors" are mandatory to place inside the rotor.

11. BALANCING THE ROTOR

PROPER BALANCED ROTOR

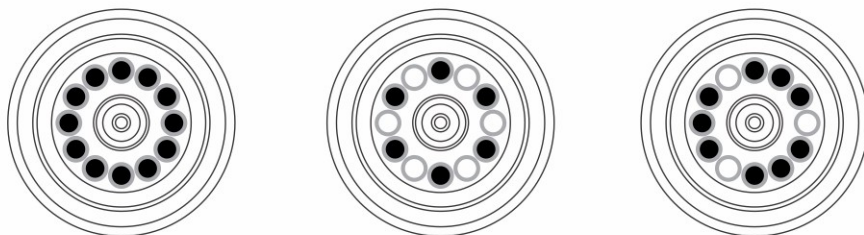

IMBALANCED ROTOR

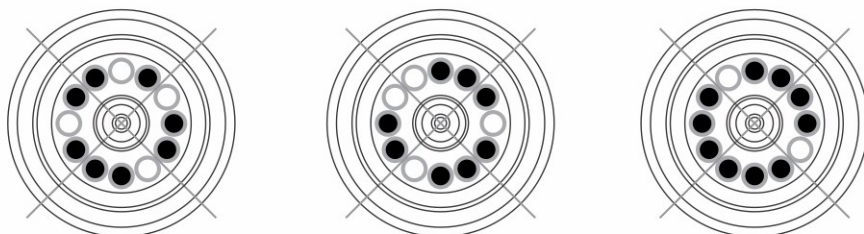

12. OPERATION

After properly installing the centrifuge, switch ON the centrifuge from the rear side by pressing the power switch. The lid status will be seen in the display. If the lid is open, the display will show "Lid" and if it is closed, the set RPM will be displayed. Please ensure that the Tube Holders are inside the rotor.

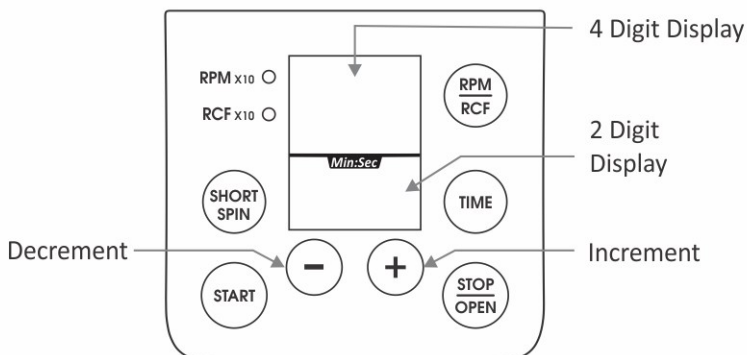

12. OPERATION

12.1 START

After setting parameters such as speed & timer as instructed below press START button to run the machine.

12.2 STOP/OPEN LID

To stop the machine at any point of time press "STOP" button. The lid will open automatically. The LID will open on its own once the completion of the run. During ramp no other button will work except for the STOP button.

12.3 SPEED

Upon turning the power on the machine, RPM/RCF display will be of previous set speed. The speed can be set from 500-15000 RPM. The speed can be set by using "+" button for increment & "-" button for decrement of the values. The increment/decrement is in the 100 RPM only. The Shown values will be multiples of 10 (x10). The values get saved automatically after blinking for 5 times.

12.4 RPM-RCF SWITCH

Long Press the RPM/RCF button to change the mode from RPM to RCF. The switch over will be indicated by the LED on respective mode. While RCF mode is ON, speed is to be read as value x10 in the display window. The maximum RCF of the centrifuge is 15596 xg. Press the speed button to see the corresponding Value.

12.5 TIME

Upon turning the power on the machine, RPM/RCF display will be of previous set timer. The timer can be set from 1 minute to 99 minutes & infinite mode. The timer can be set by using increment (+) and decrement (-) button. The set timer will automatically get saved. The timer works as countdown which means the timer will run in descending order during the operation of the machine.

12.6 SHORT-SPIN OPERATION

The centrifuge can be operated for a short run by pressing and holding the SHORT SPIN button. The centrifuge will continue to run as long as the Short-Spin button is pressed and the time in seconds will count up for 1 minute after 1 minute time count up in minute on the time display. After releasing short spin button the time in the display shows duration of short spin. The Short-Spin speed is based on the last run settings remaining in the memory or set rotational speed prior to short spin as required.

12.7 INCREMENT / DECREMENTS

Press "+" and "-" buttons is increase and decrease the speed or time values normally.

12. OPERATION

12.8 OPENING THE CENTRIFUGE LID IN CASE OF POWER FAILURE

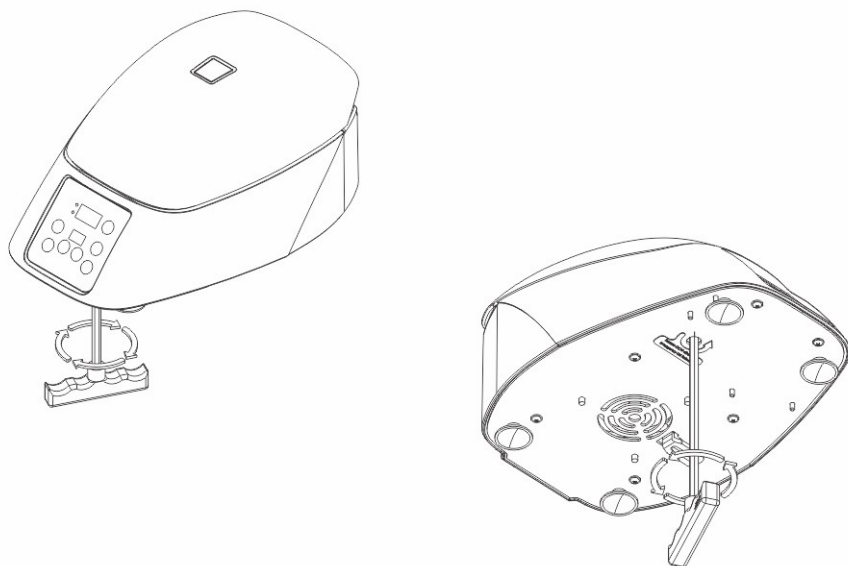

Disconnect the centrifuge from the main supply. Wait until the rotor comes to a standstill (this may take some time). Once the rotor has stopped, use the T-allene key from bottom side of the unit, rotate the T-allen key in counterclockwise direction as indicated in above figure this will open the centrifuge lid in case of emergency lid opening.

12.9 IMBALANCE DETECTION

This centrifuge is equipped with an imbalance detection safety feature. When the rotor is not loaded symmetrically, imbalance detector gets activated. This will cut off the centrifugation & error “Err55” will be shown on the display. To correct the imbalance, open the centrifuge lid and correct the imbalance load using methods described in the balancing the rotor section (page no.4) of this manual. After correctly loading the tubes into the rotor turn off the centrifuge & turn it back on.

13. TROUBLESHOOTING

The centrifuge has a self-diagnostic function. If a problem occurs, an error/warning code will be displayed on display screen and the operator can be determine the malfunction with the warning code below.

13. TROUBLESHOOTING

ERROR	PROBLEM	SOLUTION
No display	No main power connection	Check power & properly plugin power adaptor at both ends
	Power failure	Check the main fuse of the lab.
	Improper connection	Connect adaptor properly
Lid open	Lid is closed correctly	Close lid correctly
	Error with lid closing and opening mechanism	Contact service representative
Err 55	Rotor not loaded symmetrically	Load the rotor symmetrically & restart the centrifuge
Centrifuge lid cannot be opened	Rotor is still spinning	Wait for the rotor to come to a stop
	Power failure	Press emergency lid release after rotor stops
Centrifuge shakes during acceleration & makes loud running noises while running	Rotor is not loaded symmetrically	Load rotor symmetrically & restart operation
	Either a broken tube, damage to the rotor or motor is the cause for run noise	Replace broken tube. For damaged rotor/motor contact a service representative
	Rotor is damaged	Remove & change rotor
Display error	Loose connection of display	Contact service representative
Err 1	Latch motor damaged, Latch jammed or any Limit switch of latch got damaged	Contact service representative

13. TROUBLESHOOTING

Err 52	Rotor is Stuck	Turn OFF the centrifuge, Check & fit the rotor properly & turn ON the centrifuge
Power tripping	Cable not fit properly	Remove cable and connect properly
Last run memory not displayed	Turning ON centrifuge immediately after turning it OFF	Maintain 3 seconds gap Between switch OFF and switching ON again
System gets hang	Electronics error	Switch off centrifuge and switch it ON again. If the error still shows, contact service representative
"INIT" message display	If power failure occurs during the operation of device, when it comes back the unit will restart & indicate this message	Wait till the message disappears

IMPORTANT NOTE:

1. *If the centrifuge is working slow or hot due to overdraw current, restart the centrifuge and check it again.*
2. *Do not use liquid with density higher than 1.2g/ml for full load operation.*

14. MAINTENANCE AND CLEANING

1. The rotor and the outside of the centrifuge should be cleaned regularly with a moist cloth.
2. Ensure that while cleaning the unit it is not plugged in.
3. The brushless motor in the centrifuge does not require routine maintenance. Any required service should be performed by authorized, qualified personnel only. Repairs performed by unauthorized personnel may void the warranty.
4. Always keep the centrifuge housing, rotor chamber, rotor and rotor accessories clean. All parts should be wiped down periodically with a soft cloth. For more thorough cleaning, use a neutral cleaning agent (Ph between 6 and 8) applied with a soft cloth. Excessive amounts of liquid should be avoided. Liquid should not come into contact with the motor.
5. After cleaning, ensure that all parts are dried.
6. Do not place the rotor into the cleaning solution!

15. WARRANTY STATEMENT

This product is warranted to be free from defects in material and workmanship for a period of two (2) years from date of purchase. Your product will be duly repaired upon prompt notification in compliance with the following conditions :

This warranty is valid only if the product is used for its intended purpose and within the guidelines specified in this instruction manual. This warranty does not cover damage caused by accident, neglect, misuse, improper service, natural forces or other causes not arising from defects in original material or workmanship. This warranty does not cover any incidental or consequential damages, commercial loss or any other damages from the use of this product.

The warranty is invalidated by any non-factory modification, which will immediately terminate all liabilities on us for the products or damages caused by its use. The buyer and its customer shall be responsible for the product or use of products as well as any supervision required for safety. If requested the products must be returned to the distributor in well packed and insured manner and all shipping charges must be paid.

Some states do not allow limitation on the length of implied warranties or the exclusion or limitation of incidental or consequential damages. This warranty gives you specific legal rights. This warranty is given expressly in lieu of all other warranties, expressed or implied.

The purchaser agrees that there is no warranty of merchantability or of fitness for any intended purpose and that there are no other remedies or warranties, expressed or implied, which extend beyond the description on the face of the agreement. This warranty is only applicable to the original purchaser.

Products received without proper authorization will not be entertained. All items returned for service should be sent postage prepaid in the original packaging or other suitable carton, padded to avoid damage. We will not be responsible for damage incurred by improper packaging.

All items returned for service should be set postage prepaid in the original packaging or other suitable carton, added to avoid damage.

This warranty is valid only if the warranty is registered with the supplier within 30 days from the date of purchase.

For you reference, make a note of serial number, date of purchase and supplier here.

Serial No.:

Purchase Date:

Supplier:

16. PRODUCT DISPOSAL

In case the product is to be disposed of, the relevant legal regulations are to be observed.

Information on the disposal of electrical and electronic devices in the European Community.

The disposal of electrical devices is regulated within the European Community by national regulations based on EU Directive 2012/19/EU on waste electrical and electronic equipment (WEEE). According to these regulations, any devices supplied after 13.06.05 in the business to business sphere, to which this product is assigned, may no longer be disposed off in municipal or domestic waste. They are marked with the following symbol to indicate this.

As disposal regulations within the EU may vary from country to country, please contact your supplier if necessary.



Accumax Lab Devices Private Limited

Plot No. 15, 16 & 32 GIDC Electronic Park SEZ, Sector 26, Gandhinagar, Gujarat, India - 382026.

Website: www.neuation.com